

SUNSET 5.6M HEXAGONNAL RETRACTABLE UMBRELLA - S56H

METRIC

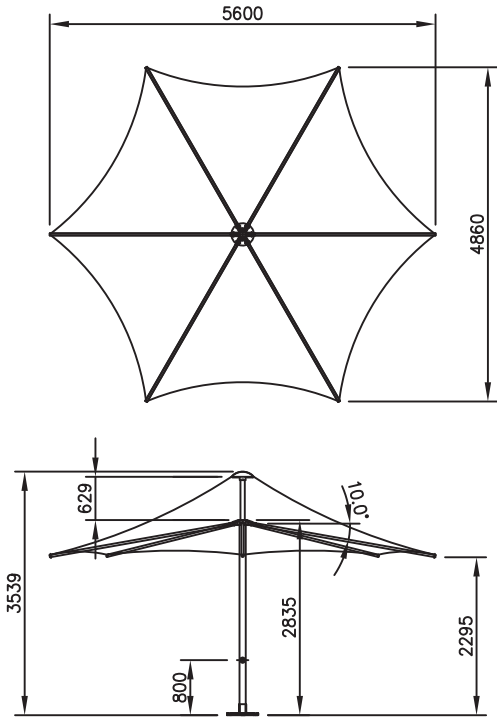

CODE: S56H
 SUNSET 5.0 M HEXAGONAL UMBRELLA

IMPERIAL

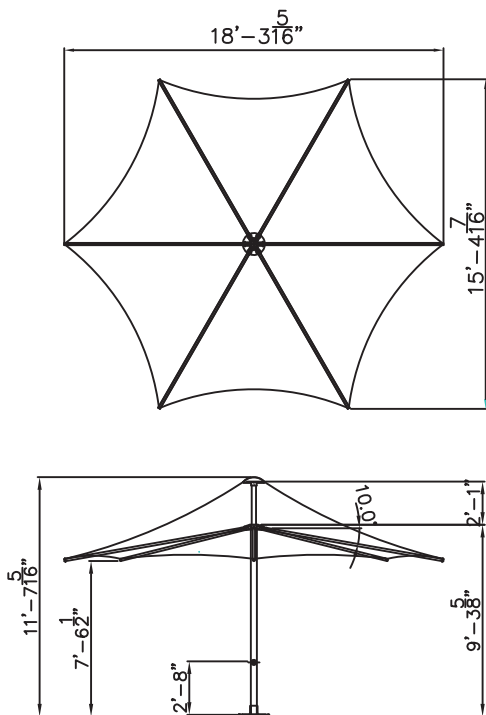

CODE: S56H
 SUNSET 18 FT. HEXAGONAL UMBRELLA

Specifications:

- Low maintenance, heat reflective, UV treated, fully welded membrane.
- Stainless steel edge cable for even tension of roof material.
- Purpose built internal mechanism for ease and speed of mobilizing canopy.
- Removable handle (with stop) to raise and lower canopy.
- All metal work is Structural Aluminium or 316 Stainless steel and powder coated.
- 10 year Frame - anti rust policy.
- 2 year warranty on the canopy.
- 5 year warranty on frame.
- Engineered wind rated 112 kph 75 MPH(W33) open & 148 kph 93 MPH(W41) closed

OPTIONS

- Lighting
- Electric Heaters
- PVC Curtain
- Screen Printing
- Remote Control - Motorised

