

VISTA 4.0M SQUARE CANTILEVER UMBRELLA - V40S

METRIC

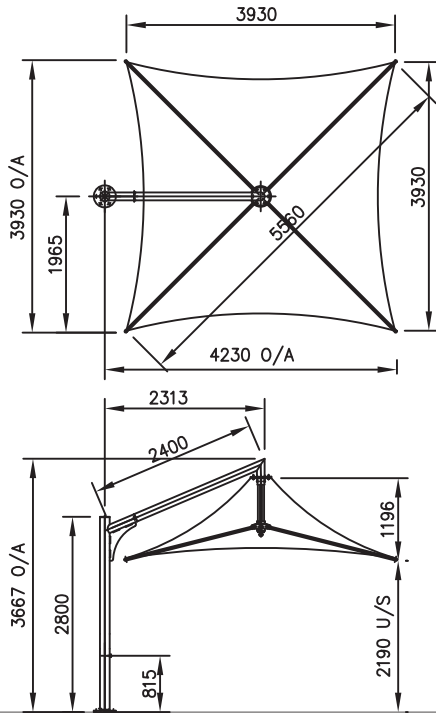

CODE: V40S
 VISTA 4.0M SQUARE CANTILEVER

IMPERIAL

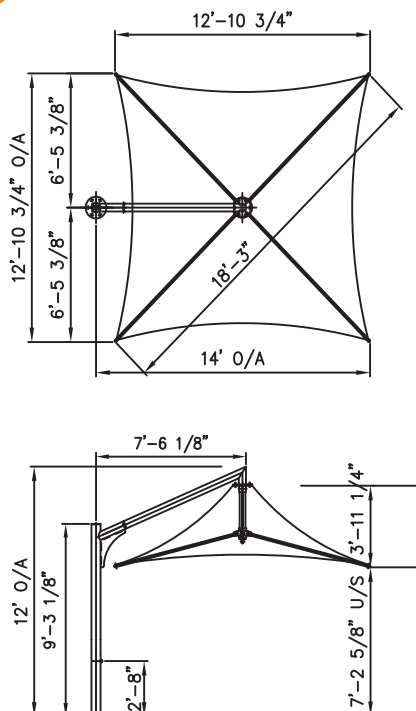

CODE: V40SC
 VISTA 13 FT. SQUARE CANTILEVER

Specifications:

- Low maintenance, heat reflective, UV treated, fully welded membrane.
- Stainless steel edge cable for even tension of roof material.
- Mast and cantilever arm are structural grade steel which is galvornised and then powdercoated.
- Arms are structural grade aluminium.
- Retractable winding mechanism allowing for the arms to collapse in extreme weather.
- 5 year warranty on the frame.
- 2 year warranty on the canopy.
- Engineered wind rated 112 kph - 75 MPH (W33) open & 150 kph - 93 MPH (W41) closed

Options:

- PVC Curtains
- Lighting
- Screen Printing
- Rain Lips
- Link Panels joining umbrellas
- 360 Degree Swivel Base

