

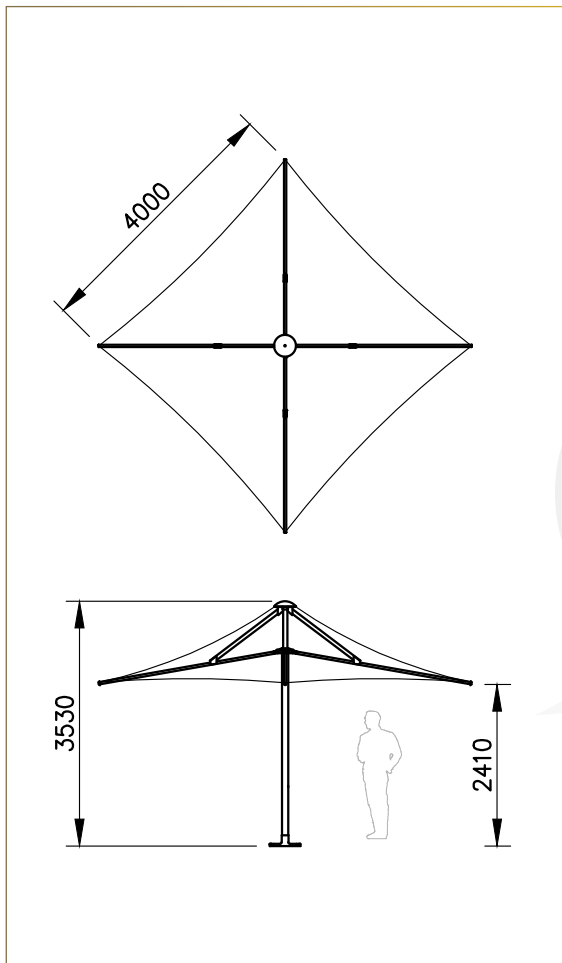

STYLES AVAILABLE			WIND RATING		FRAME MATERIAL		COLUMN TYPE			FEATURES			PRICE		
SQUARE	HEXAGONAL	RECTANGULAR	148km/h OPEN	112 Km/h	ALUMINIUM	STEEL	CENTRE COLUMN	CANTILEVERED	GAZEBO	PORTABLE	FIXED	RETRACTABLE	ENTRY LEVEL	STANDARD	PREMIUM

## T40S DIMENSIONS



**The clear choice for coastal resorts, exposed public spaces and wind-prone environments. Typhoon umbrellas are engineer certified to a wind rating W41 (148 KPH). Combine that with an industry leading structural & canopy warranty and you have shade with piece of mind.**

- Available in square, hexagonal and rectangular shapes.
- 2.4m – 5.6m standard sizing.
- Made from high tensile, structural grade aluminium with additional bracing for strength, powder coated to any colour in the Dulux/Interpon range.
- Low maintenance, translucent, heat reflective, UV treated and fully welded architectural grade PVC membrane available in a large variety of colours.
- Marine grade stainless steel catenary cable and fittings.
- 10 year frame anti rust policy, 5 year structural warranty on the frame & canopy.
- Engineer wind rated to 148 kph (W41).
- Range of accessories including lighting, heating, corporate branding & link panels.



TYPHOON 4M SQUARE UMBRELLAS



TYPHOON 3M SQUARE UMBRELLAS