

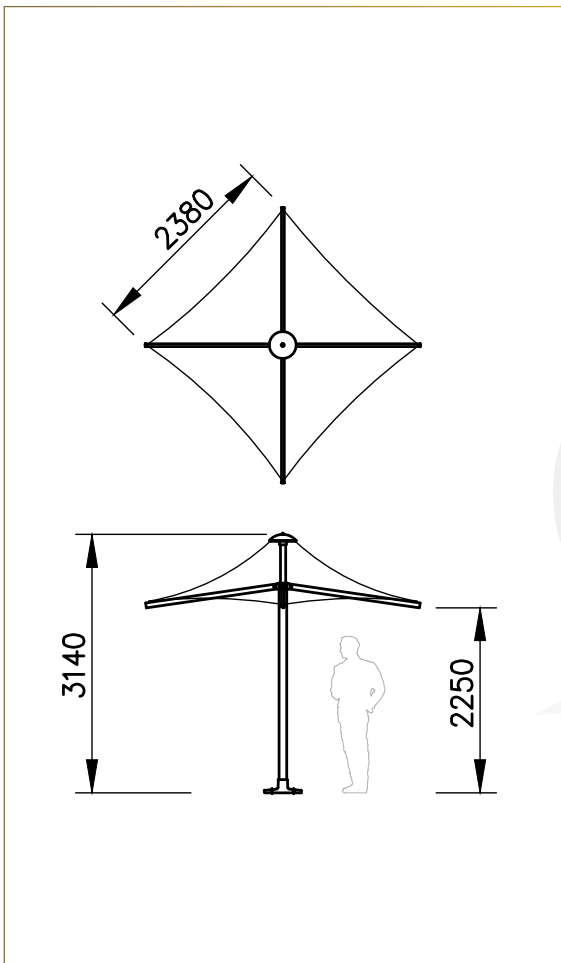

STYLES AVAILABLE			WIND RATING		FRAME MATERIAL		COLUMN TYPE			FEATURES			PRICE		
SQUARE	HEXAGONAL	RECTANGULAR	148km/h CLOSED	112km/h OPEN	ALUMINIUM	STEEL	CENTRE COLUMN	CANTILEVERED	GAZEBO	PORTABLE	FIXED	RETRACTABLE	ENTRY LEVEL	STANDARD	PREMIUM

H24S DIMENSIONS



Designed with flexibility in mind, the Horizon range is ideal for Alfresco Dining, Resorts and Entertainment Venues. Available in several shapes with high corrosion resistance materials, a wide range of accessories and a W33 (112kph) wind rating, it's easy to see why the Horizon range is a favourite.

- Available in square, hexagonal or rectangular shapes.
- 2.4m – 5.6m standard sizing.
- Made from a high tensile, corrosion resistant, structural alloy, powder coated to any colour in the Dulux/Interpon range.
- Low maintenance, translucent, heat reflective, UV treated and fully welded architectural grade PVC membrane available in a large variety of colours.
- Marine grade stainless steel catenary cable and fittings.
- 10 year frame anti-rust policy, 5 year structural warranty on the frame & minimum 5 year fabric manufacturer's warranty on the canopy.
- Engineer wind rated to 112 kph (W33).
- Accessory options include integrated PVC fabric curtains, rain diverters, link panels (to join umbrellas), corporate branding, down/up lights, heaters and speaker systems.



HORIZON 2.4M HEXAGONAL UMBRELLAS



HORIZON 3M SQUARE UMBRELLAS